

The City Farmer's Crafts Book



European Federation of City Farms

The European Federation of City Farms (EFCF)

Schapenstraat 14

1750 Lennik

Belgium

Tel. + 32 25 69 14 45 (day)

+ 32 25 32 01 90 (evening)

Fax + 32 25 32 23 22

E-mail efcf@vgc.be

Website: www.cityfarms.org

The City Farmer's Crafts Book

Don't let free materials go to waste
There's so much you can cut, colour and paste

Have a look in and outside the house
There's a whole world for you to browse

Milk cartons, plastic bottles and cups,
sticks, leaves, seeds and nuts

Use your imagination, get new ideas and enjoy
making your own musical instrument, flower or toy



Contents	page
The right tools for the job	2
What a waste	2
They grow on trees	3
Pets and puppets	4
Games and toys	12
Music and sound	14
Boats and buildings	16
Inside and outside	18
Wheel along	20
For your desk	22

The right tools for the job

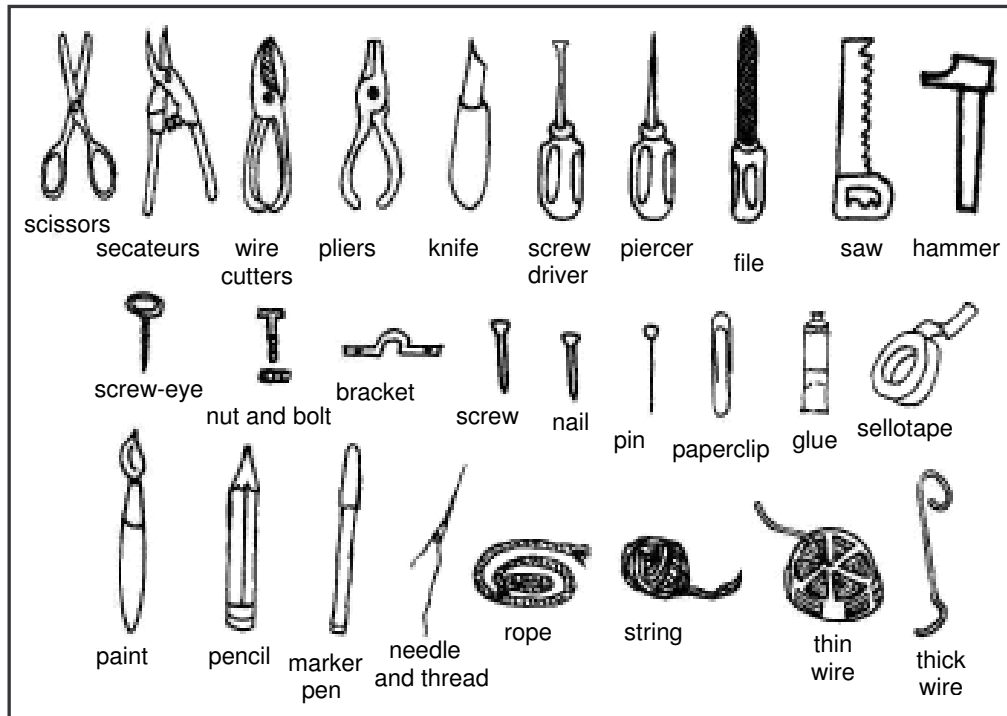

What a waste

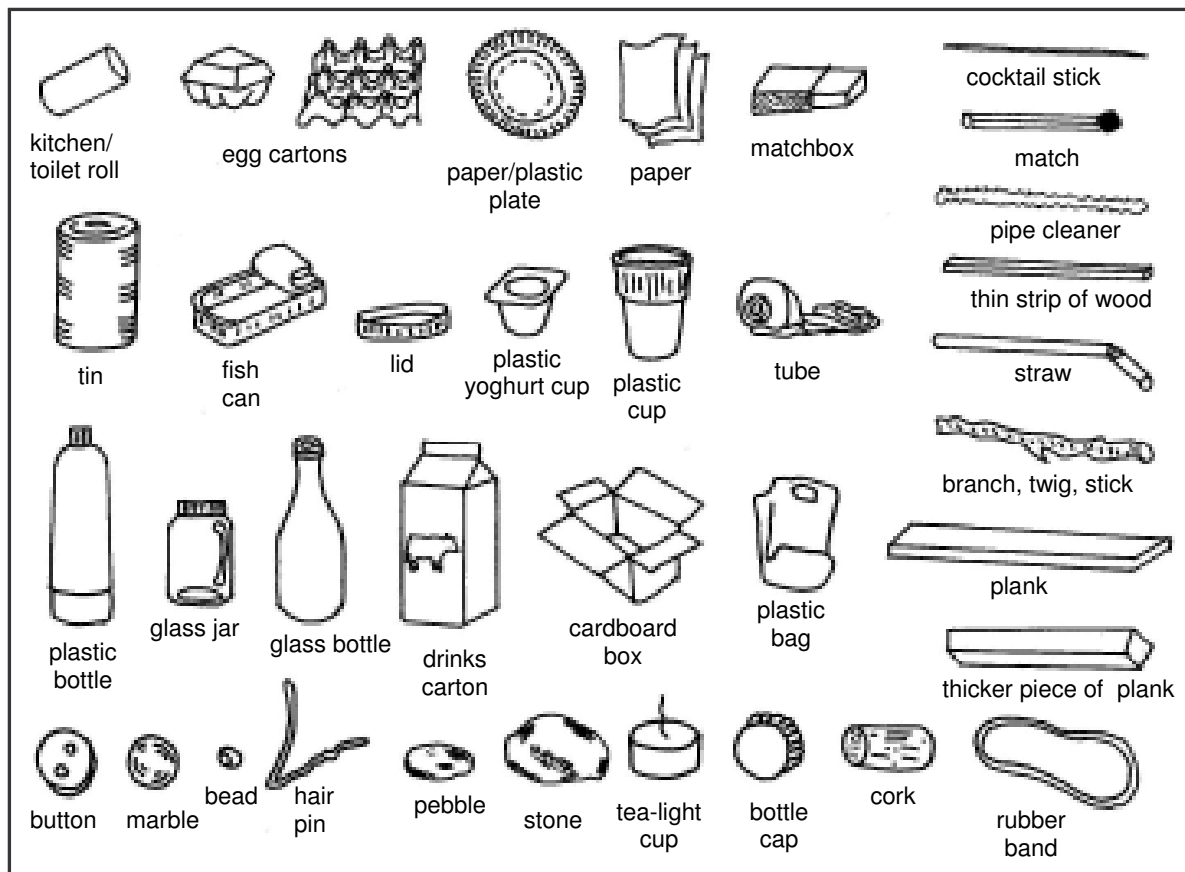

They grow on trees (and on shrubs and plants)

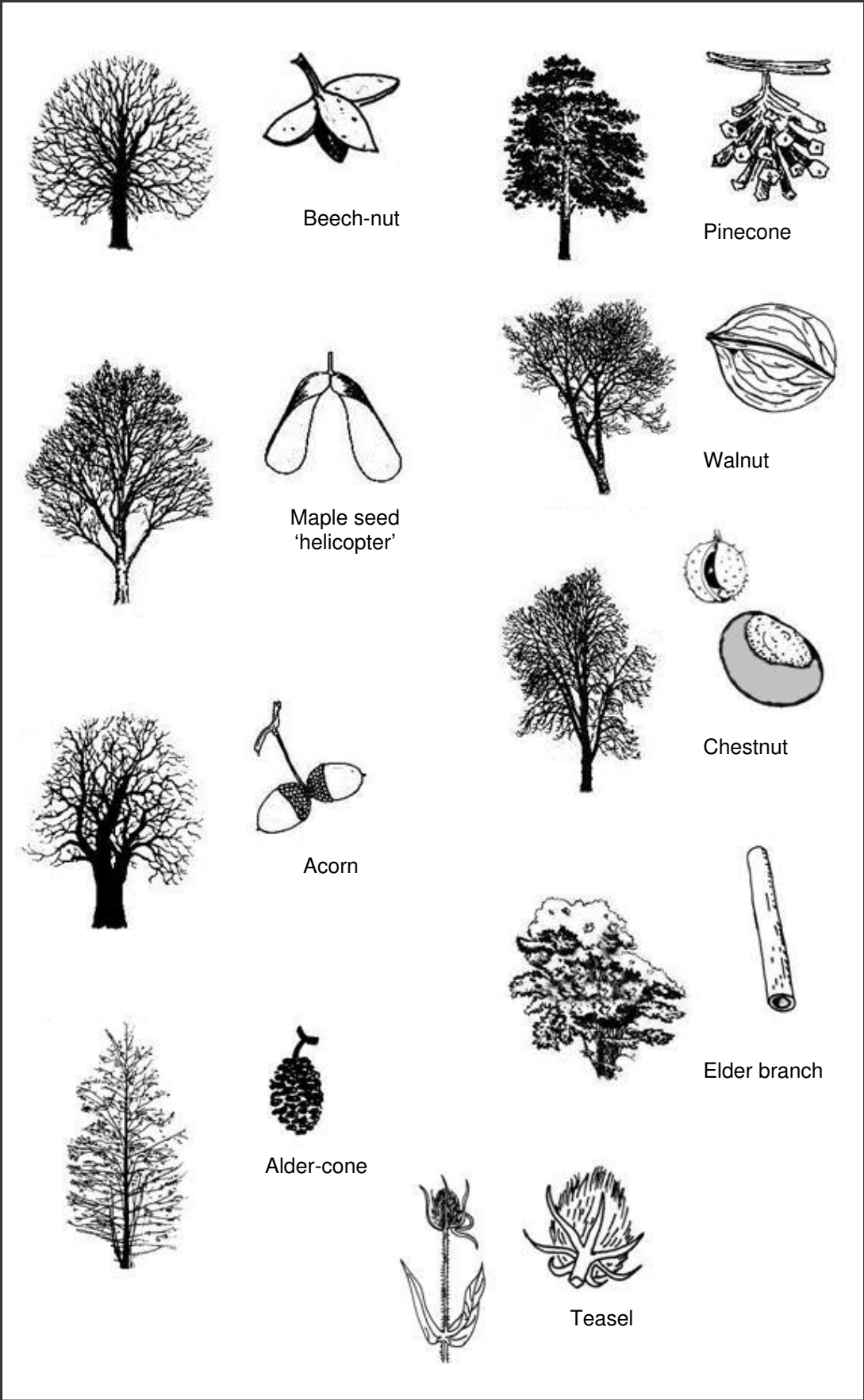

Pets and puppets

Horse

- corks
- cardboard
- piercer
- knife
- glue

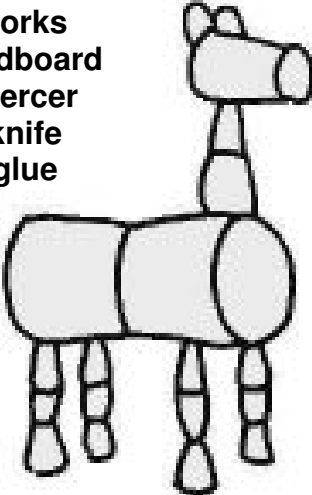

Horse

- corks
- cardboard
- matches
- piercer
- glue

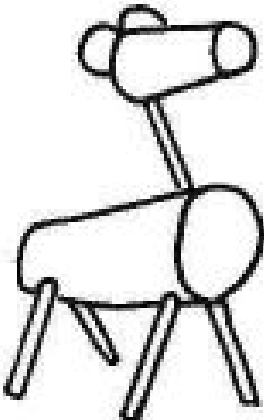

Chicken

- egg carton
- cardboard
- glue
- scissors
- knife
- paint

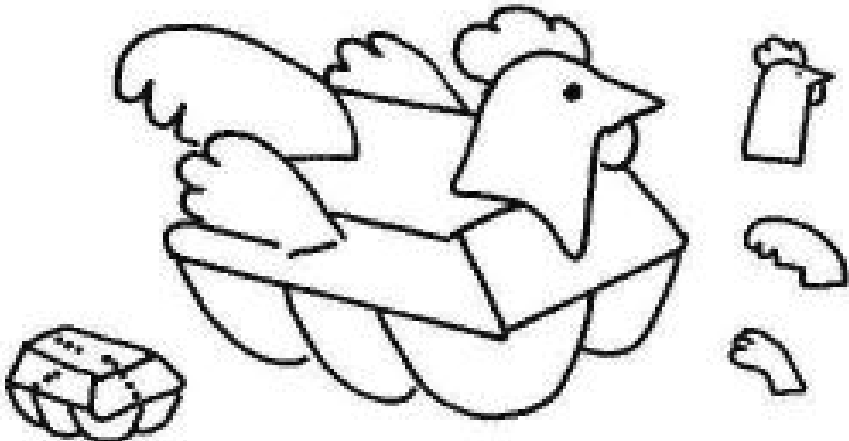

Horse

- toilet rolls
- rope
- scissors
- glue
- colouring pencils

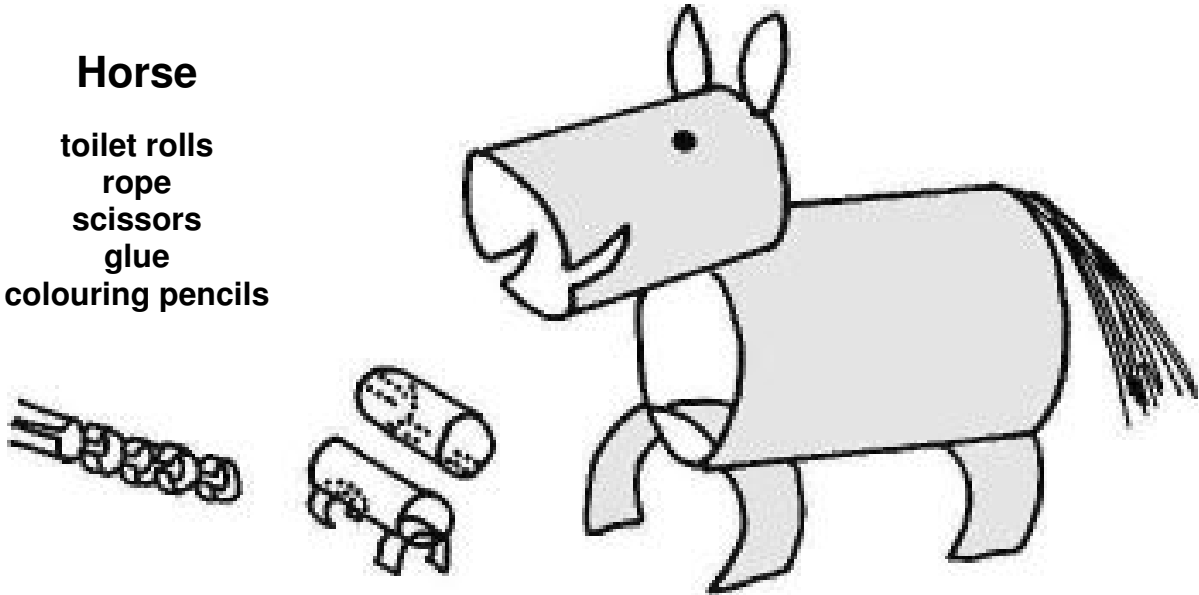

Dog and horse

chestnut
acorn / beech-nut
maple seed
matches
piece of string
piercer
glue

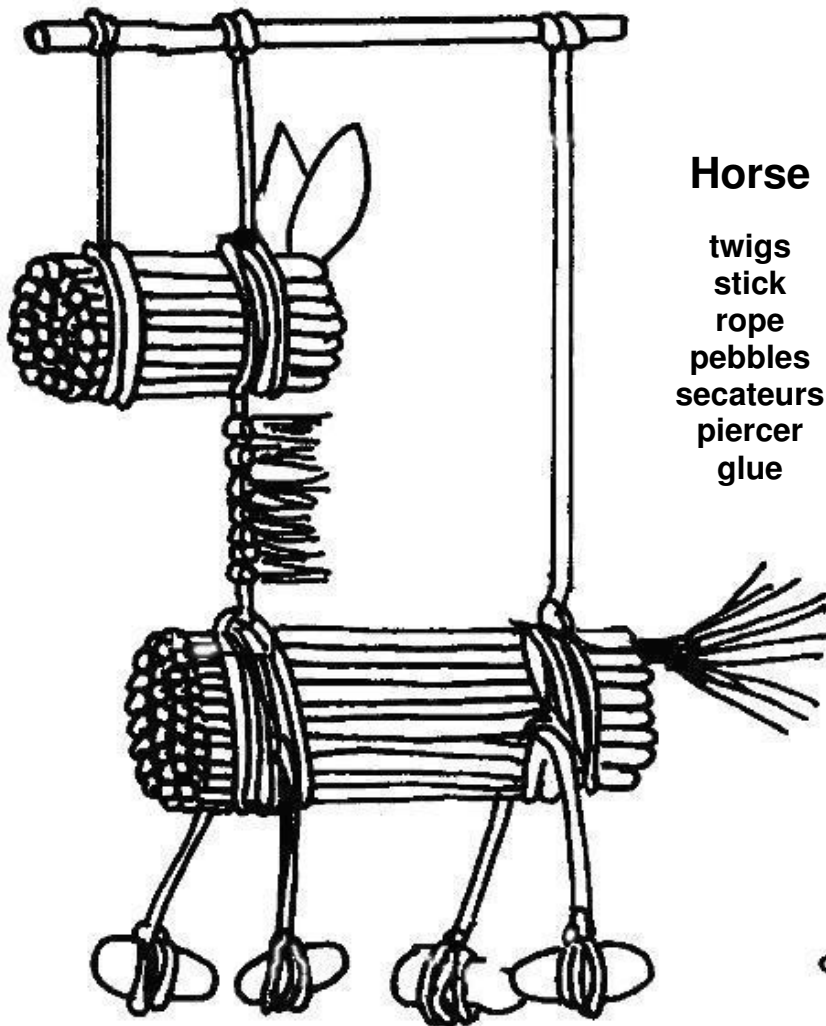
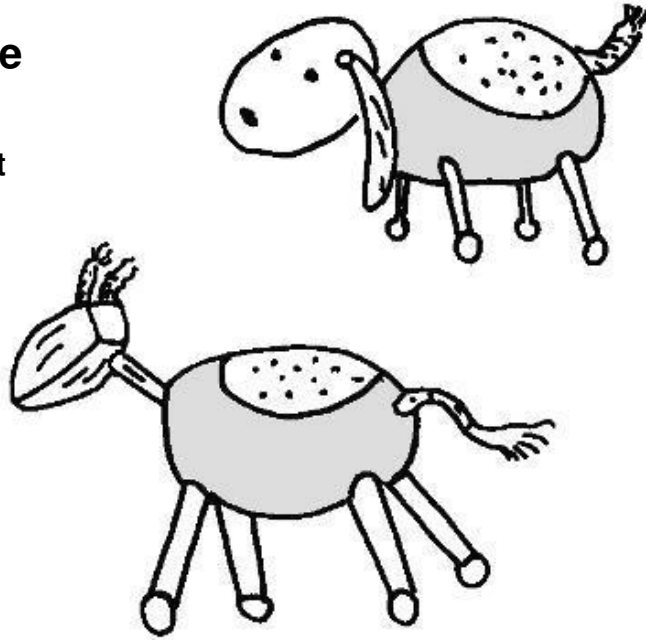

Horse

twigs
stick
rope
pebbles
secateurs
piercer
glue

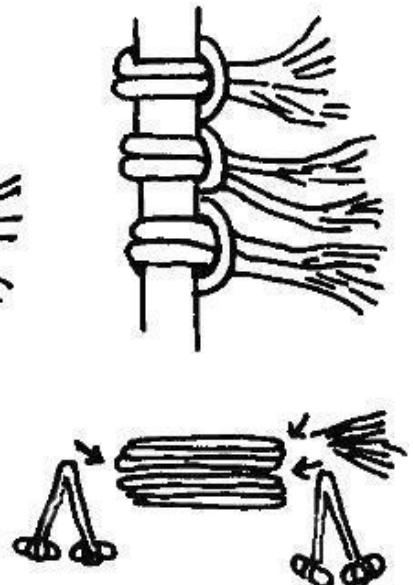

Pig



plastic bottle
paper
corks
scissors
knife
glue
paint

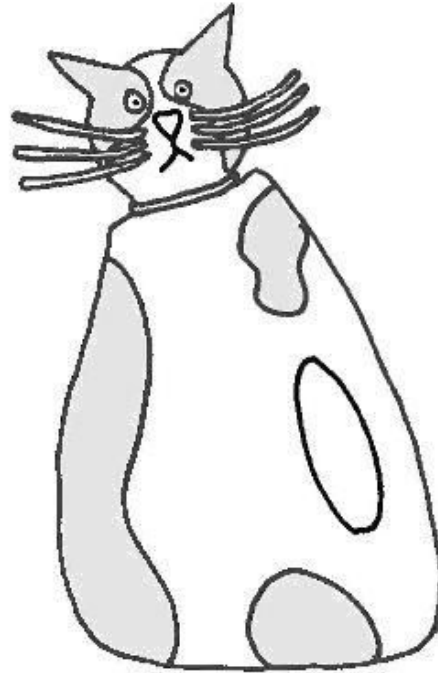

Cat

fabric softener bottle
pipe cleaners
piece of plastic
piercer
scissors
glue
paint

Mouse

ketchup bottle
piece of plastic
paint
scissors
glue
sellotape

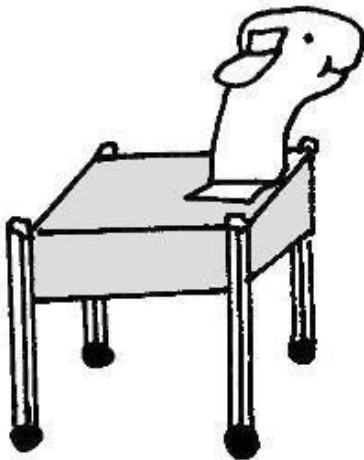
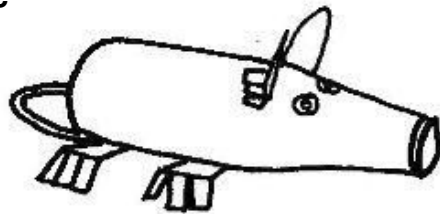

Sheep

matchbox
matches
paper
wool or cotton
scissors
glue
sellotape
marker pen

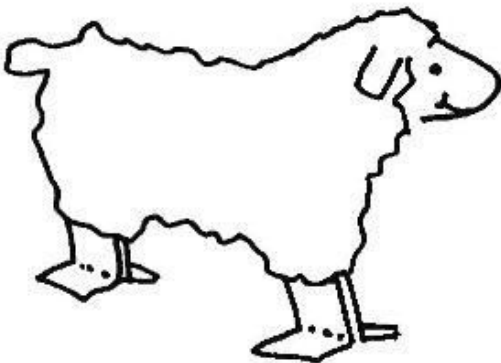
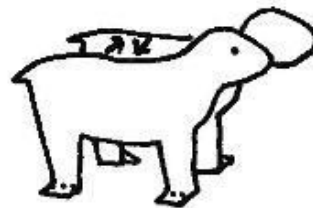

Dog

thick wire
wire cutters
pliers

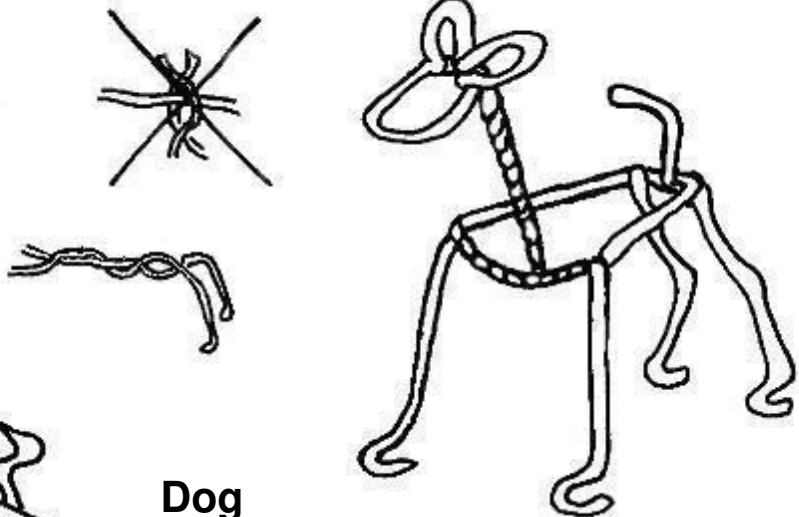

Dog

egg carton
scissors
glue

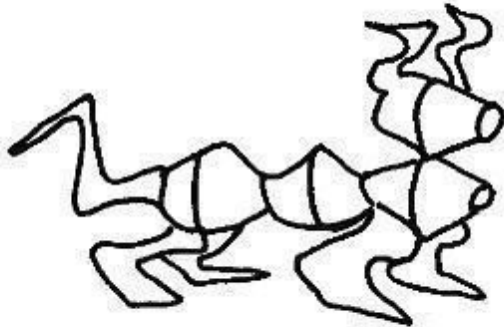

Pig

toilet roll
egg carton
scissors
glue

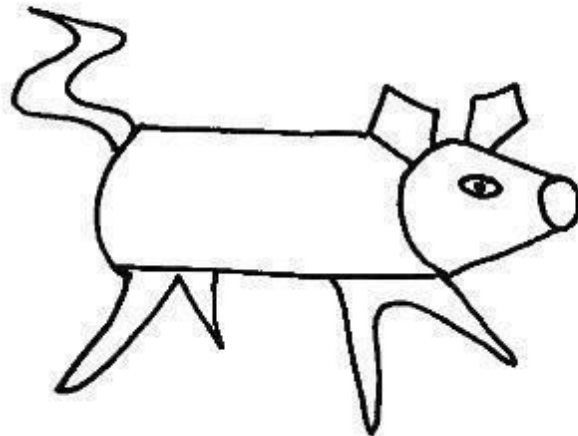

Cat and dog

toilet rolls
paper
piper cleaners
cork
piercer
scissors
glue
marker pen

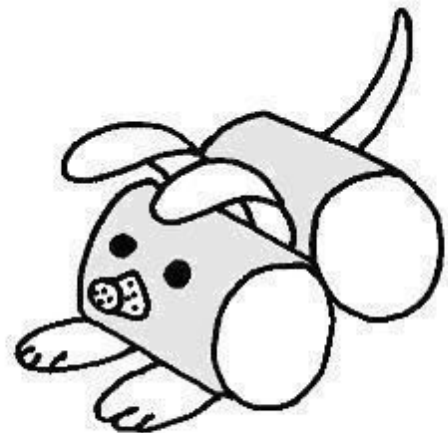
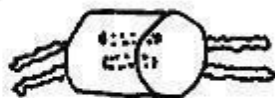
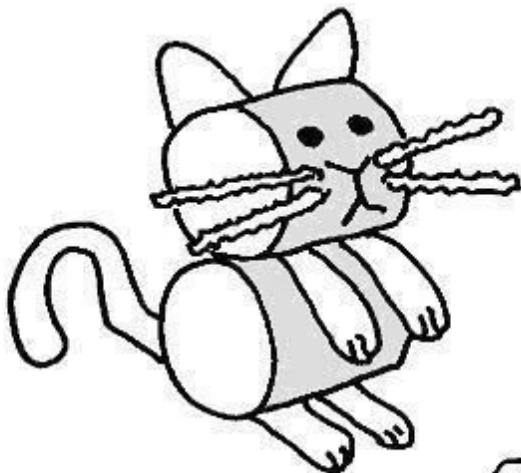

Mouse

walnut
maple seed
marble
string
glue

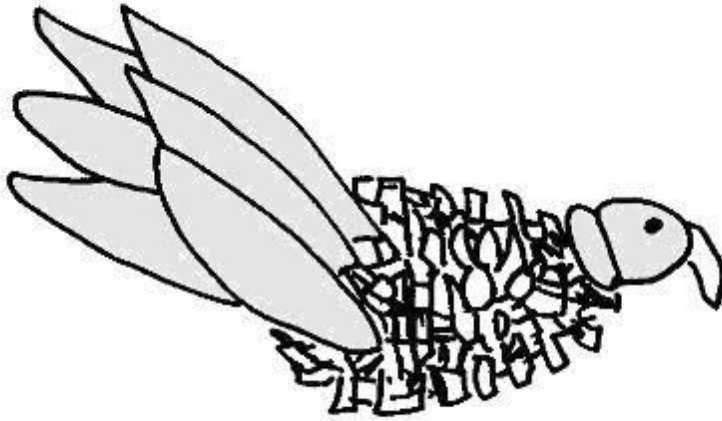
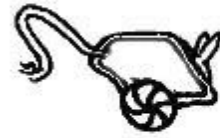

Turkey

pinecone
acorn
paper
scissors
coloring pencils
glue

Rabbit and bird

acorns
maple seeds
cocktail sticks
piercer
glue

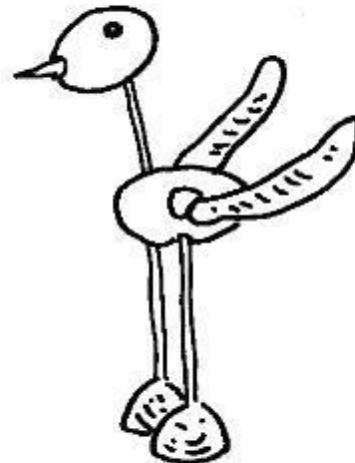
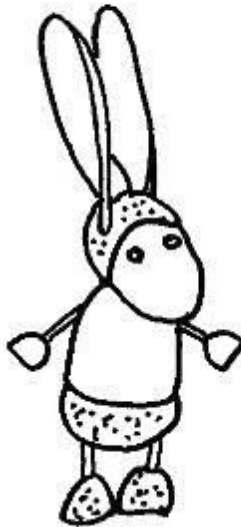

Bee

alder-cone
yellow thread
paper
scissors
colouring pencils

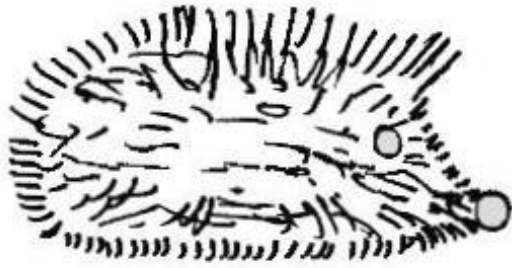

Hedgehog

teasel
pins
scissors

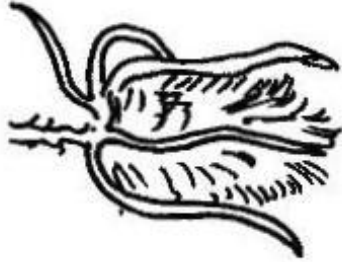

Spider

egg carton
pipe cleaners
scissors
piercer
marker pen

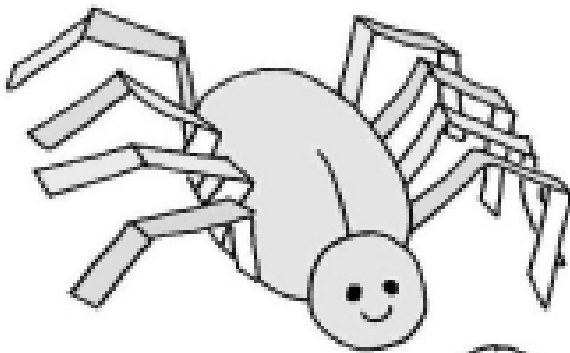
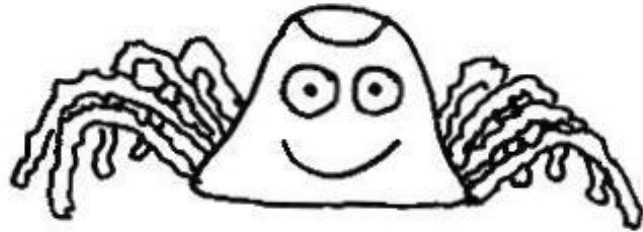

Spider

paper
scissors
glue
colouring pencils

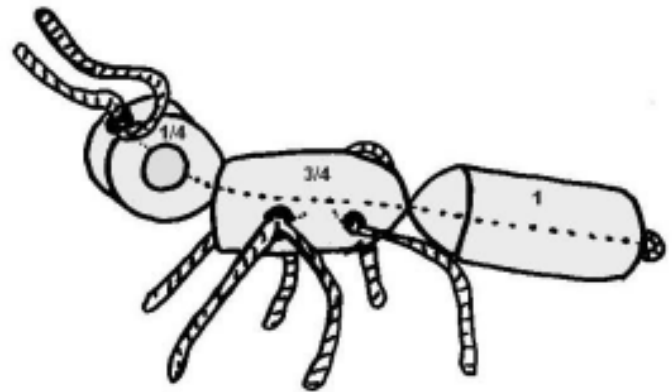

Ant

2 corks
2 drawing pins
thin wire
corkscrew
wire cutters
knife
file
marker pen

Caterpillar

toilet rolls
pipe cleaners
buttons
piercer
glue
marker pen

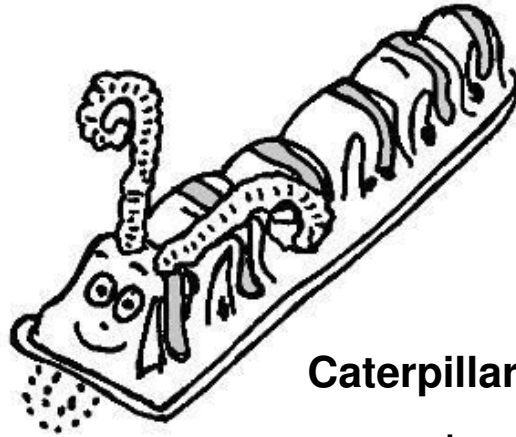

Caterpillar

egg carton
pipe cleaners
piercer
scissors
marker pen

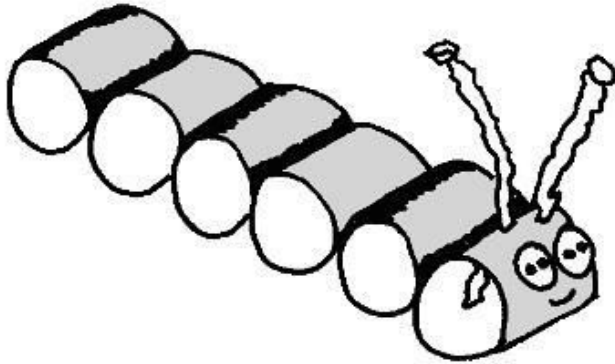

Octopus

toilet roll
stickers
scissors
marker pen

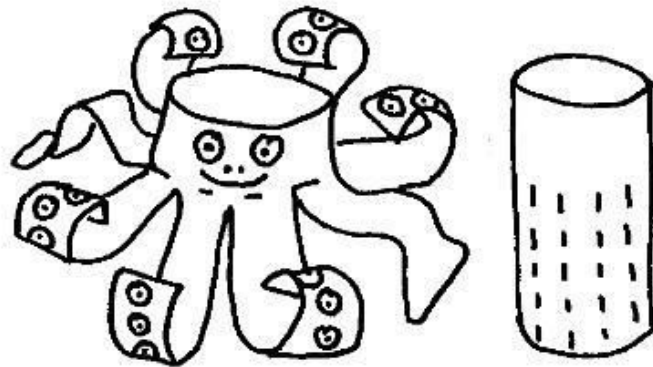

Snake

drinks cartons
string
paint

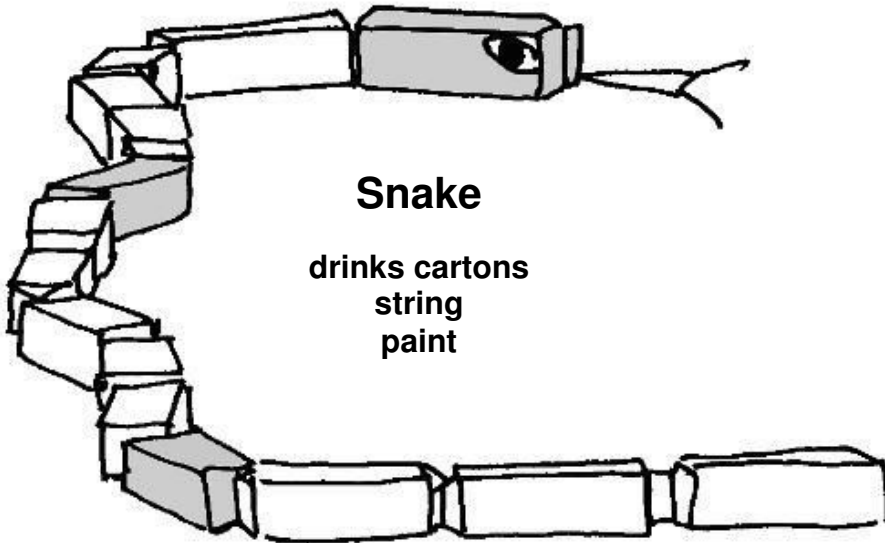

Puppets

tubes (not plastic)
bottle brush
scissors
pencil
paint

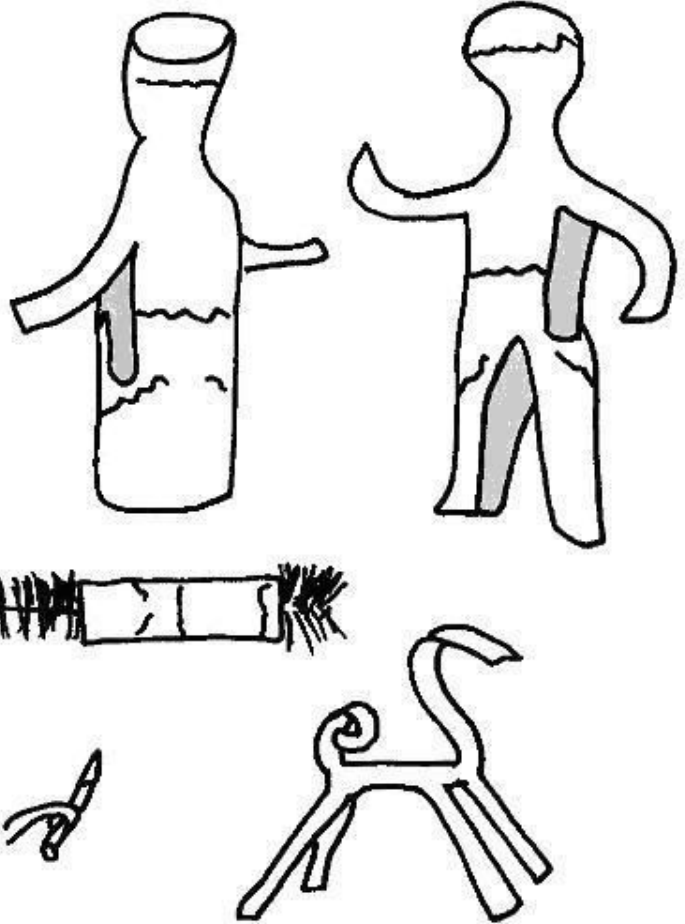
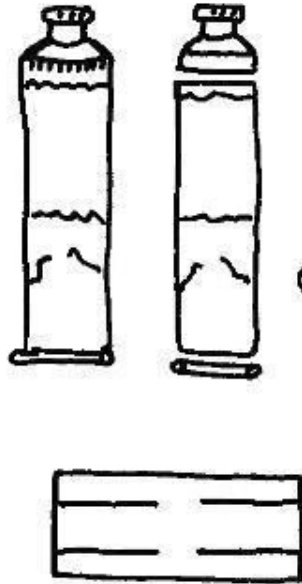

Puppet

chestnuts
acorns
cocktail sticks
thread
needle
piercer
glue

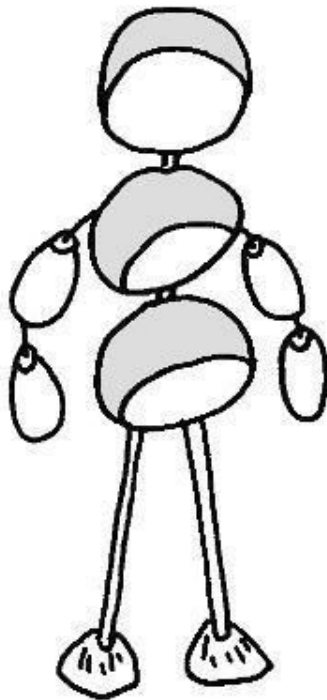

Puppet

egg carton
scissors
glue
paint

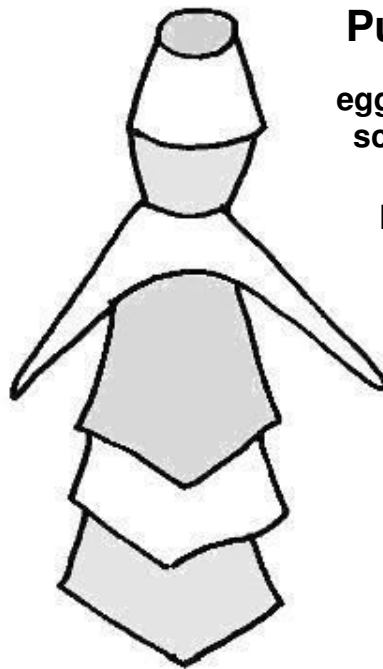

Games and toys

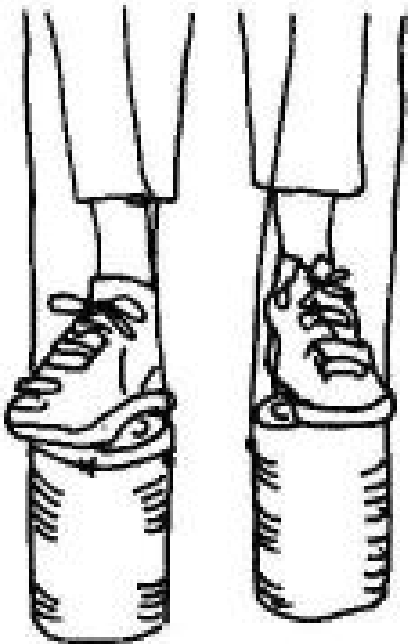

Walk on tins

- 2 tins
- rope
- hammer
- piercer

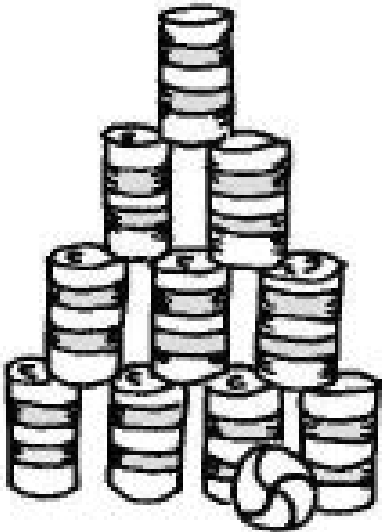

Bowling

- tins
- ball
- paint

Parachute

- plastic bag
- thread
- yoghurt cup
- piercer
- scissors

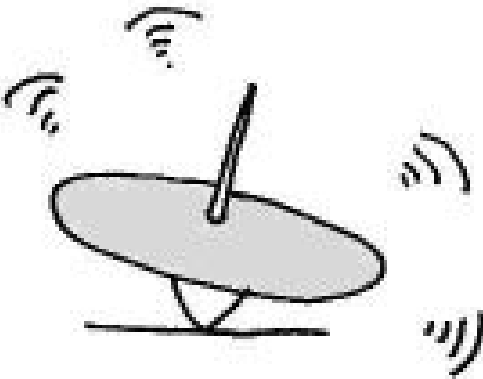
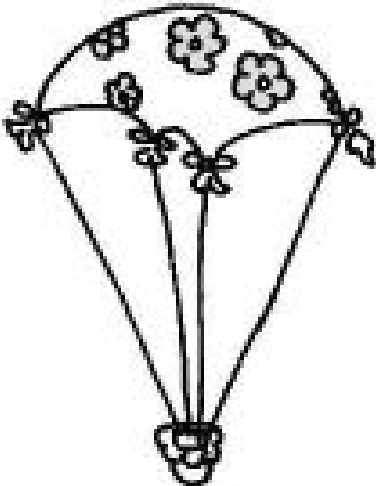

Top

- beer mat
- acorn
- cocktail stick
- piercer

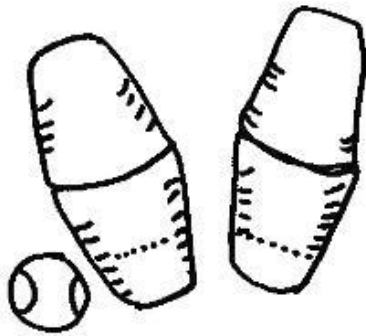

Bowling

plastic cups
sand
glue
ball

Catch ball

plastic cup
ball
string
match
piercer

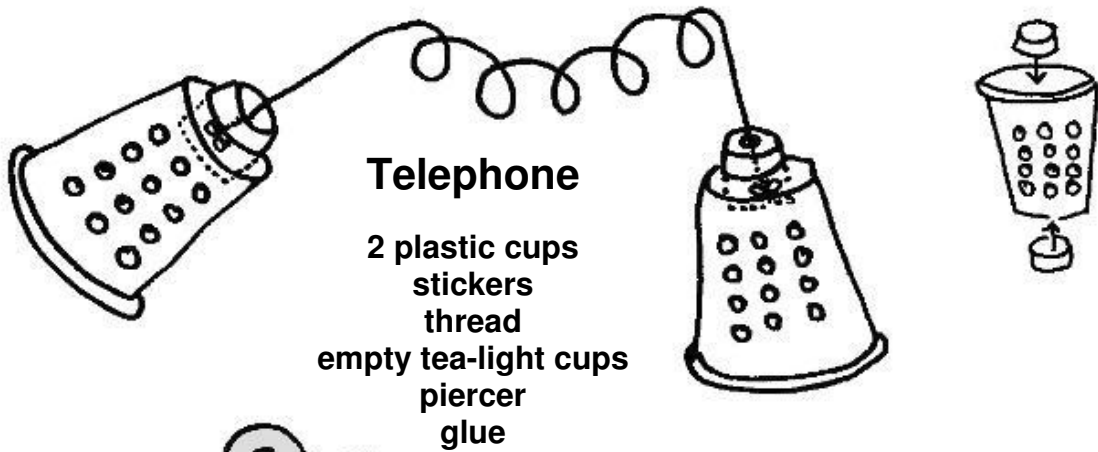
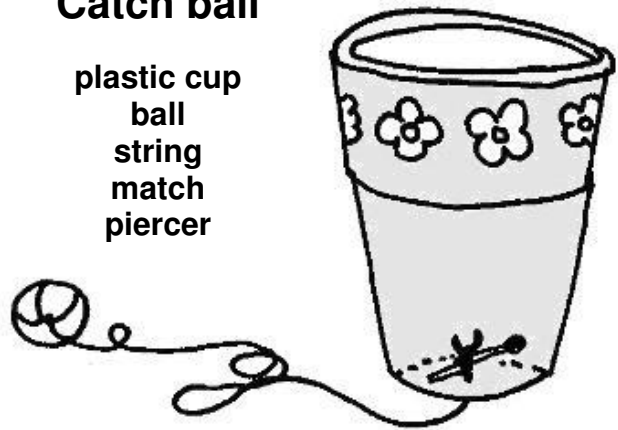

Telephone

2 plastic cups
stickers
thread
empty tea-light cups
piercer
glue

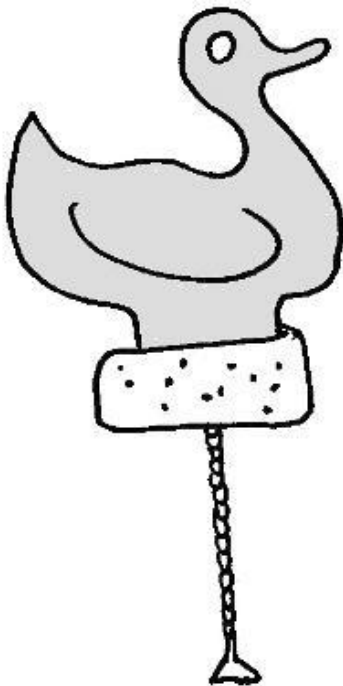

Fishing

piece of plastic
cork
long screw
stick
iron wire
screw-eye
screwdriver
sharp knife
scissors
glue
paint

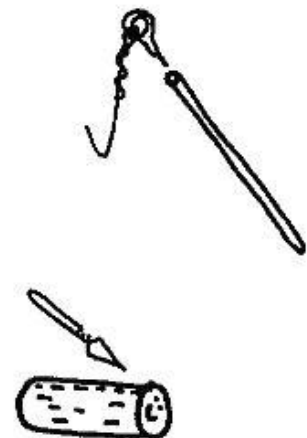

Music and sound

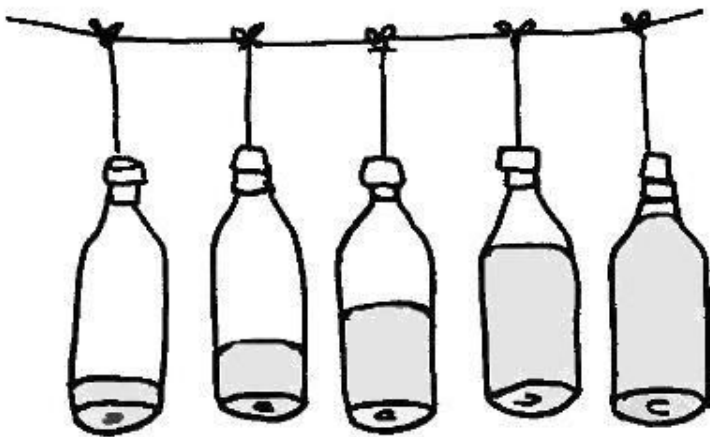

Bottle organ

rope
glass bottles
water

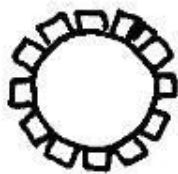

Maraca

toilet roll
cardboard
gravel or sand
scissors
glue
paint

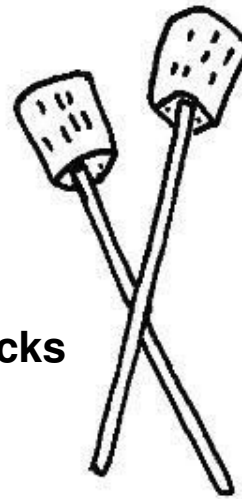

Drum sticks

corks
sticks
piercer
glue

Drum set

tins
string
piercer

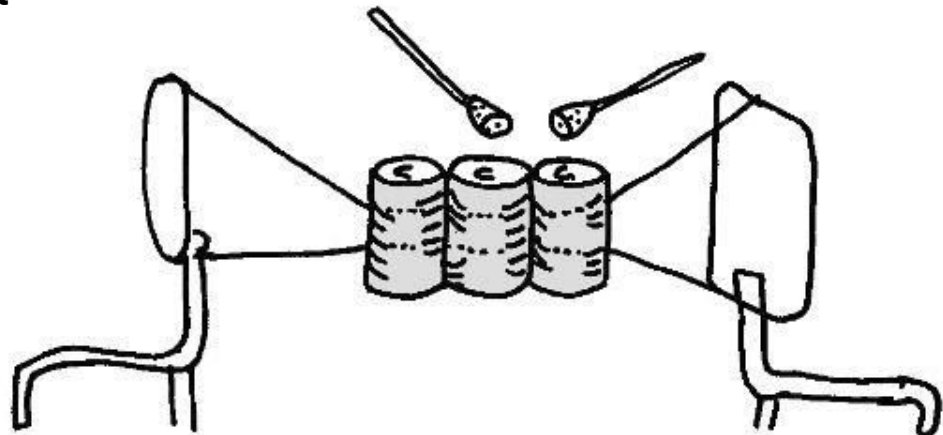
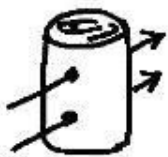

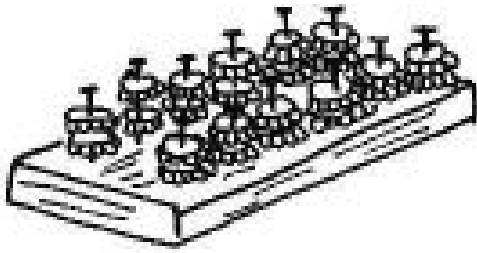

Tambourin

piece of wood
bottle caps
hammer
nails

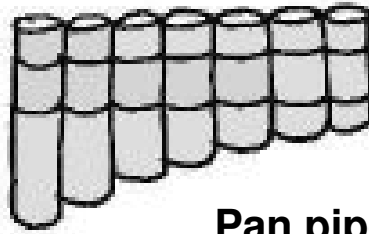

Pan pipes *

pvc pipes
saw
glue
wire

Rattle

elder branch
stick
file
piercer

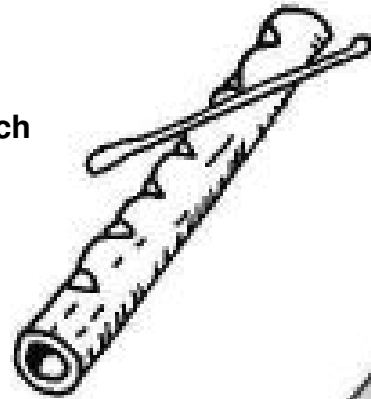

Buzzzzzz

button
thread

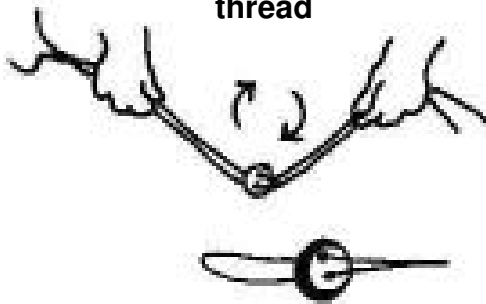

Guitar

tissue box
cardboard
rubber bands
pencil
scissors
glue

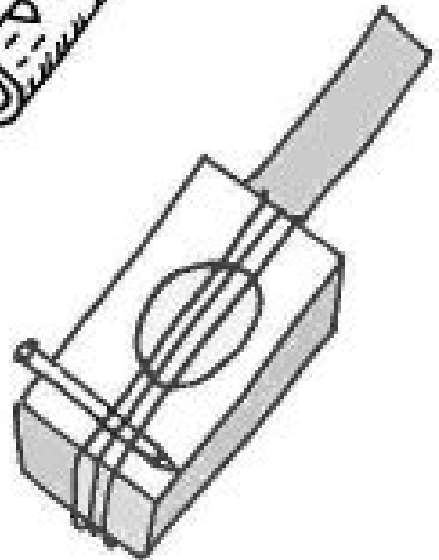

Harp *

fish can
piece of wood
hairpins
thick wire
stick
strip of wood
saw
hand drill
wire cutters
piercer
pliers
paint

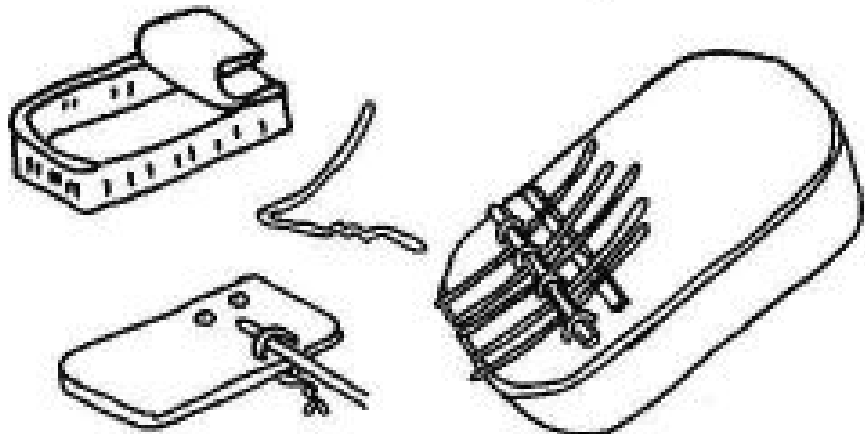

*
Ask an adult
for help

Boats and buildings

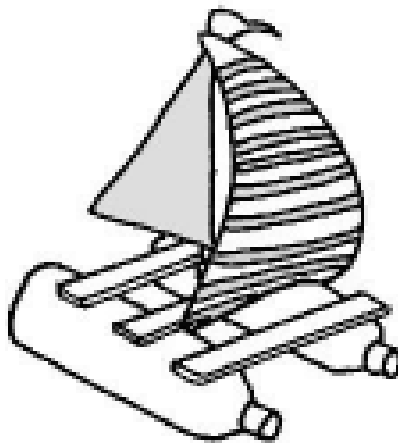
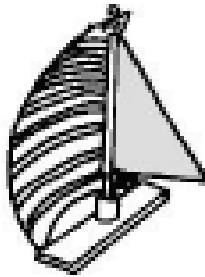

Catamaran

- 2 plastic bottles
- 3 strips of wood
- plastic bag
- 1 cork
- 1 stick piercer
- scissors
- glue
- paint

Catamaran

- milk carton
- plastic or paper plate
- knife
- glue

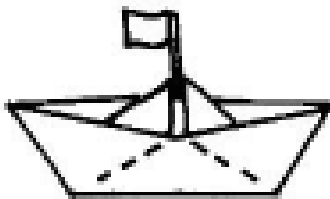
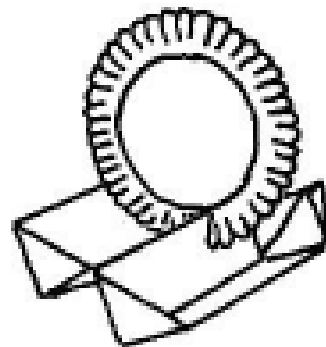
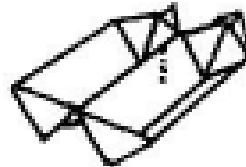

Boat

- paper
- coctail stick
- marker pen
- scissors
- glue

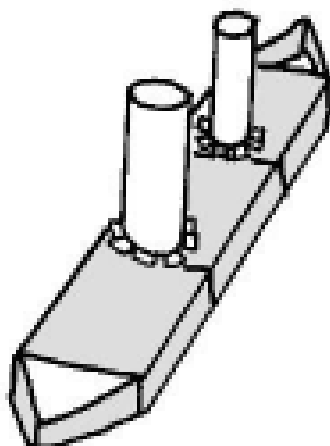
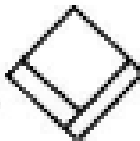
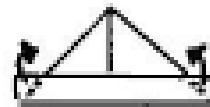
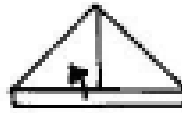

Boat

- 3 matchboxes
- cardboard tubes
- scissors
- glue
- paint



House

milk cartons
cardboard
paper
sellotape
scissors
glue
marker pen

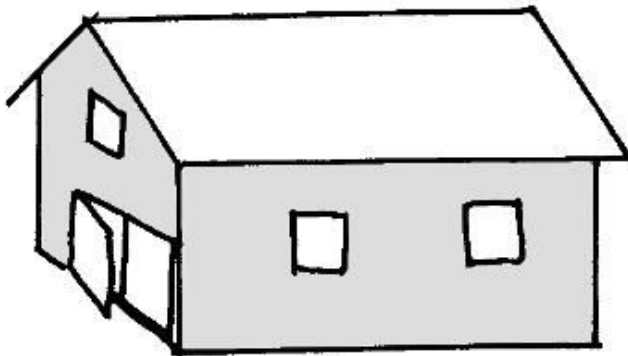

Barn

cardboard box
cardboard
scissors
glue
paint

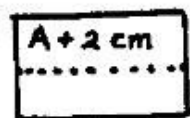

2 x B + 1 cm

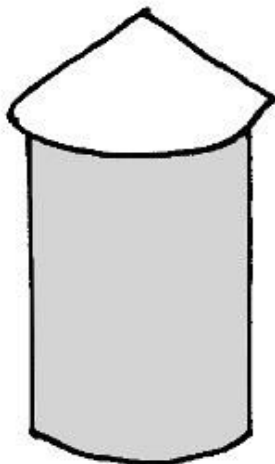

Silo

crisps box or oatcakes box
cardboard
scissors
glue
paint

Inside and outside

Flowers

- egg carton
- pipe cleaners
- scissors
- piercer
- paint

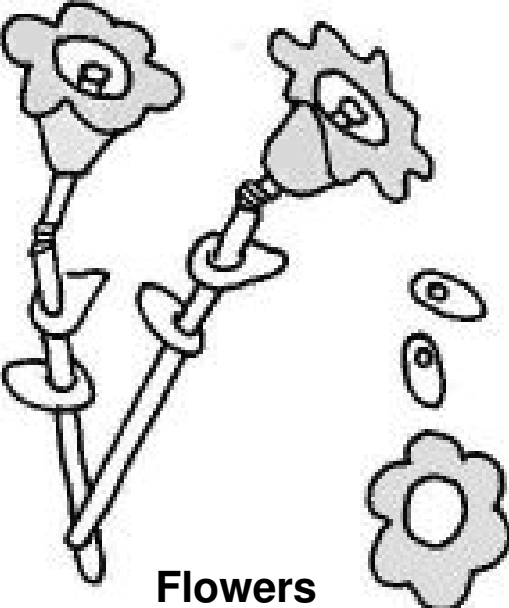
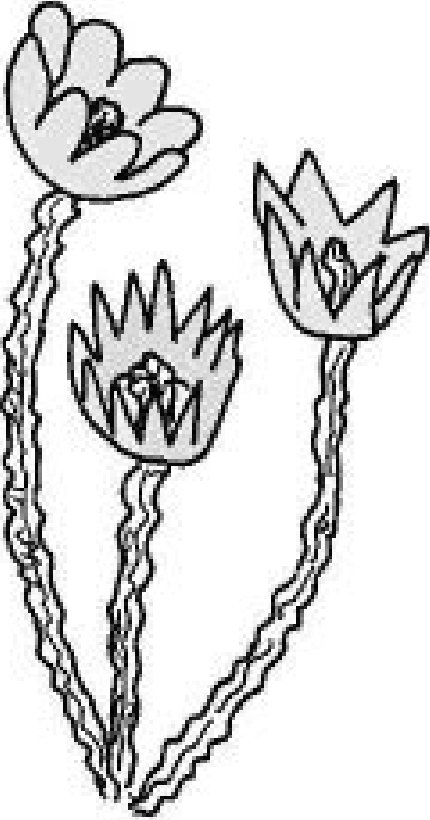

Flowers

- yoghurt cups
- straws
- piece of plastic
- piercer
- scissors
- glue
- paint

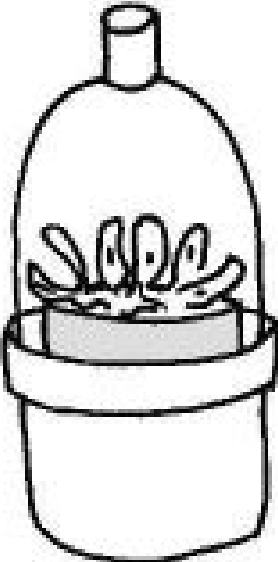

Greenhouse

- plastic plant pots
- plastic bottle
- scissors

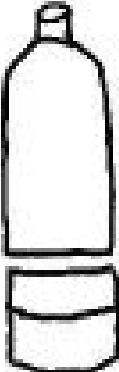

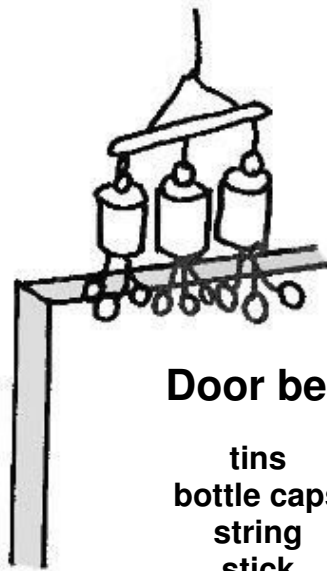

Door bell

tins
bottle caps
string
stick
hammer
nail
paint

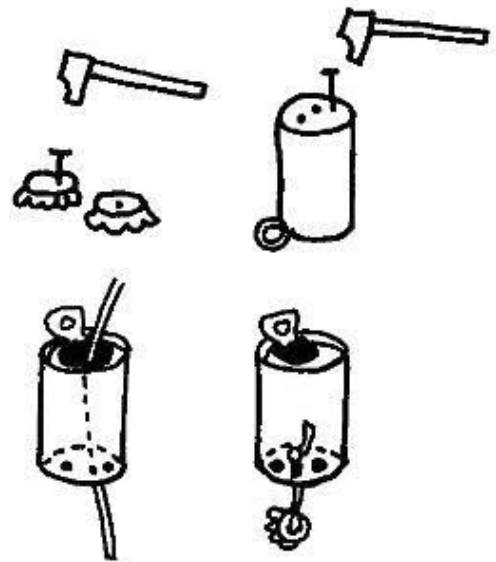

Snowflakes

glass jar
puppet
glycerine / water (3 : 1)
pieces of white plastic bag
scissors
glue

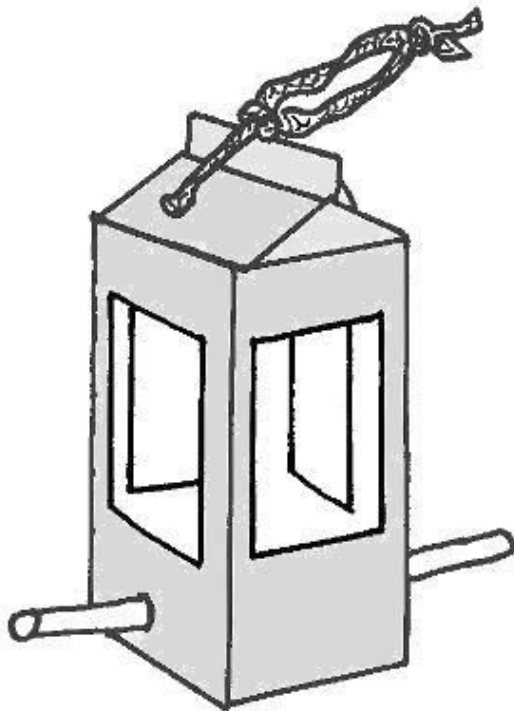

Bird house

drinks carton
stick
rope
scissors
paint
glue
pebbles (for weight)

Wheel along

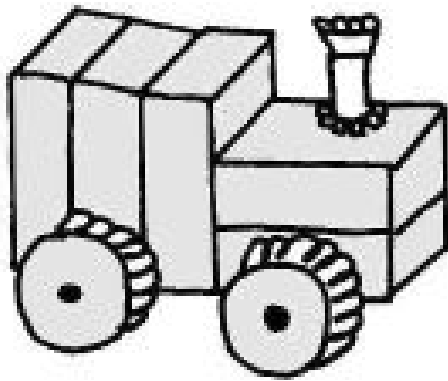

Tractor

- matchboxes
- bottle caps or buttons
- cardboard tubes
- sellotape
- scissors
- glue

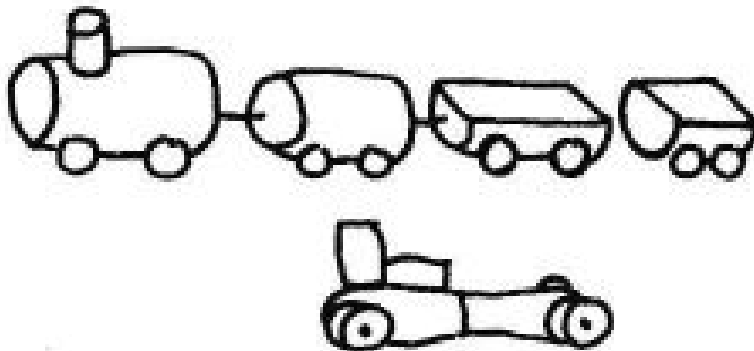
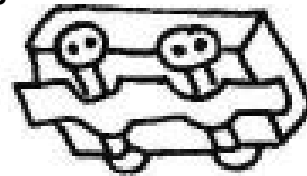
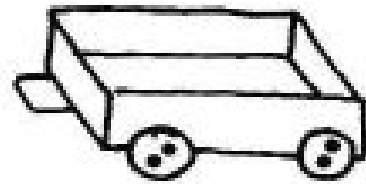

Train and racing car

- corks
- piercer
- thread
- glue
- sharp knife
- paint

Wheels

- pot lids
- marker pen cover
- thick wire
- beads
- sellotape
- hammer
- wire cutters
- nail
- glue

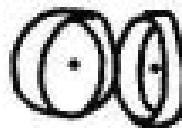
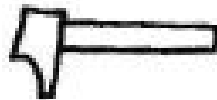
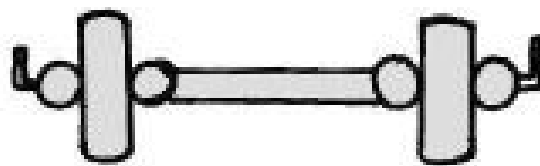

Whimsical wheels

paper 10 x 10 cm
straw
paperclip
marker pen
scissors
glue

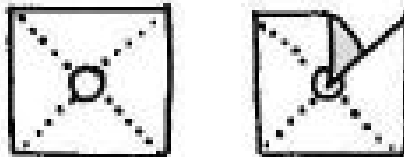
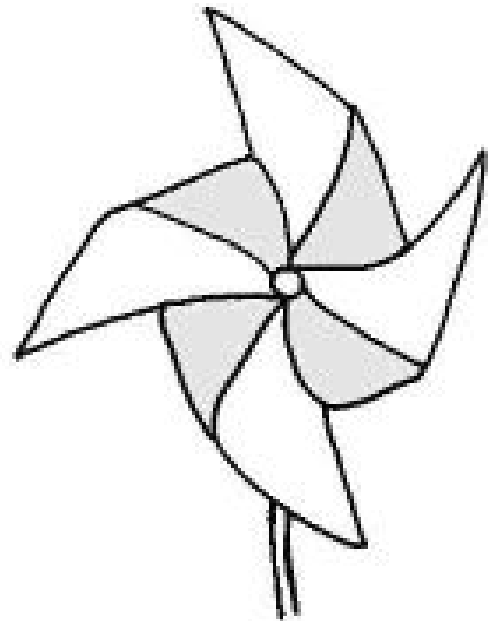

Bicycle

pot lids
thick wire
wire cutters
hammer
nail
pliers

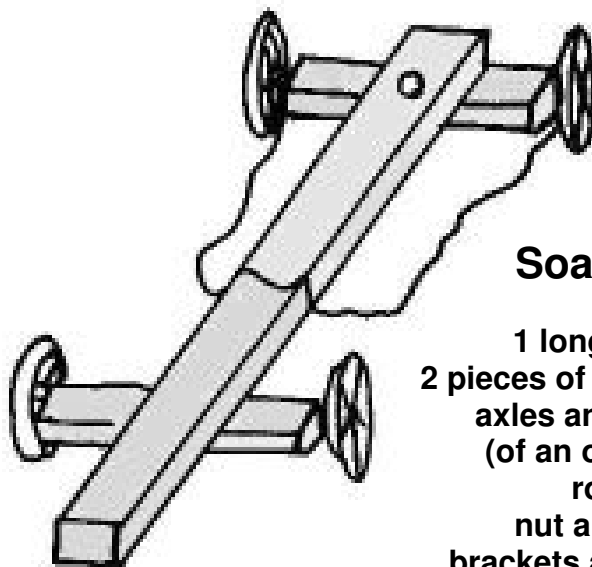
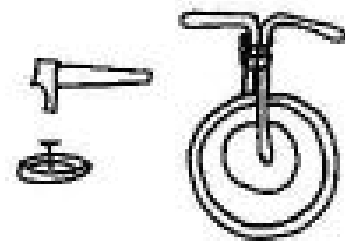
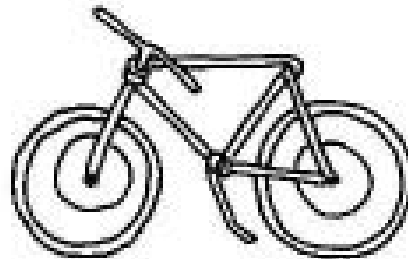

Soap box *

1 long plank
2 pieces of thicker plank
axles and wheels
(of an old pram)
rope
nut and bolt
brackets and screws
ring screws
hand drill
saw
screwdriver

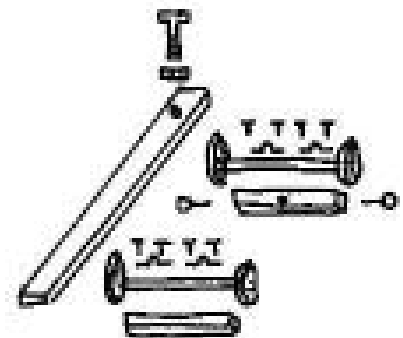

*
Ask an adult
for help

For your desk

Paper weight

stone
paint

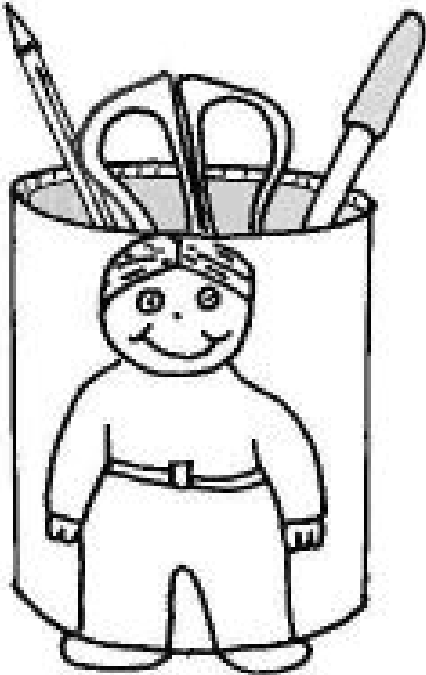
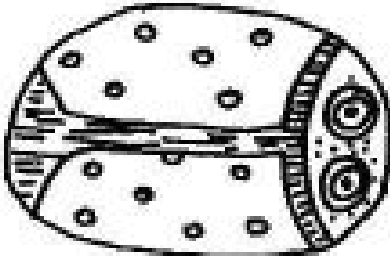
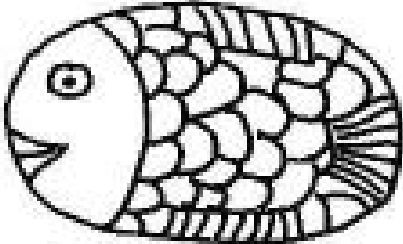

Pen holder

tin
paper
marker pen
glue
scissors



Memo holder

pine cone
paint

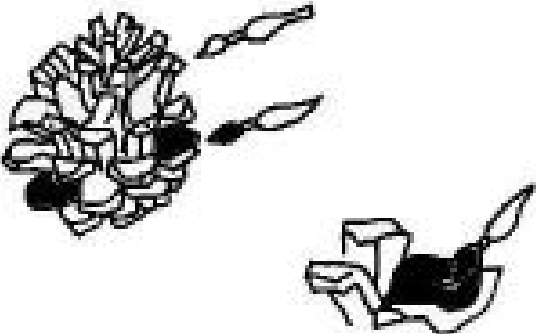

**The European Federation of City Farms (EFCF)
is based on the following values:**

- Commitment to Sustainable Development,
(combining social, environmental and economic goals)
- Equal opportunities and social justice
- Inclusion of disadvantaged people
(addressing social exclusion)
- Civil society
- Co-operation



EFCF Aim

To promote the interests and mutual co-operation of Kinderboerderijen, Jeugdboerderijen, Gezinsboerderijen, Fermes d'Enfants, Fermes d'Animation, Jugendfarmen, Aktivspielplatze, City Farms, 4H-Farms and similar organisations that actively promote the equal access and involvement of children, young people and adults through practical experience in a wide range of educational, environmental, recreational, social and economic activities focused around farming within a framework of sustainable development.

EFCF Strategy Objectives

- To promote the work and the image of City Farms and raise the profile of the EFCF, member Federations and City Farms.
- To help and facilitate member Federations and City Farms to deliver programmes, activities and research that benefit other Federations and City Farms.
- To distribute useful information, in particular good practice, to member organisations.
- To collaborate and network with other like-minded organisations (particularly community run land based groups) to help further the aims and aspirations of member Federations and their City Farms.
- To place all our work within the over-riding theme of Sustainable Development (considering the economic, social and environmental aspects of all programmes and developments).
- To work within a framework of democracy, equal opportunity and social justice, encouraging member organisations, wherever possible, to address issues of social exclusion.
- To encourage and promote co-operative European working in the City Farm movement.
- To raise funding for the operation of EFCF and participating member Federations to deliver agreed programmes and action.
- To empower people to improve their own lives and environment in peaceful coexistence.

www.cityfarms.org

